

# Montážny nákras

## 16mm / 19mm inštalčné rozmery zásuvky (so zaistovacím zariadením)

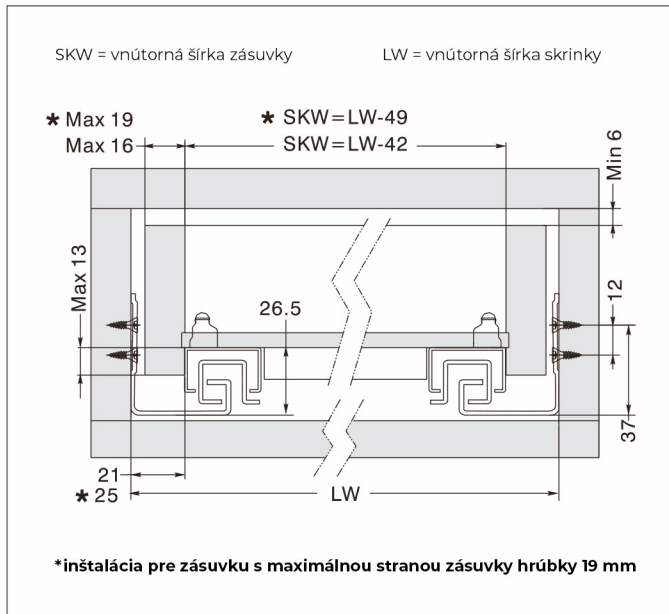

## 16mm / 19mm inštalčné rozmery zásuvky (s kolíkom)

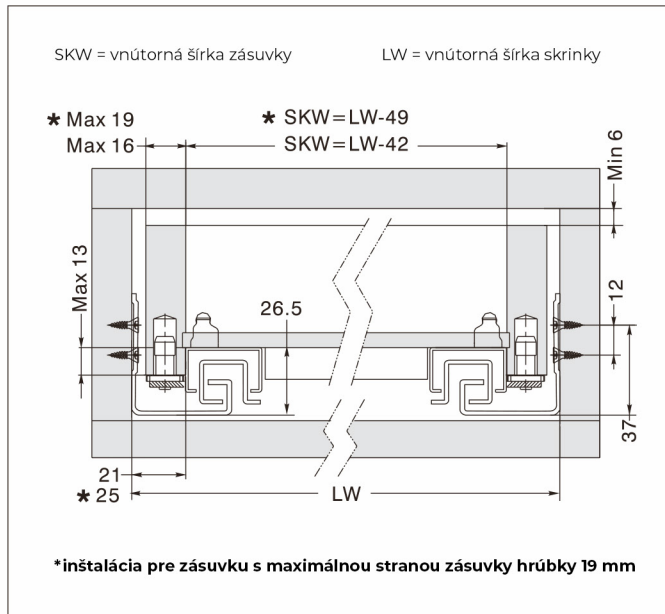

## Štandardný rozmer inštalácie zásuvky

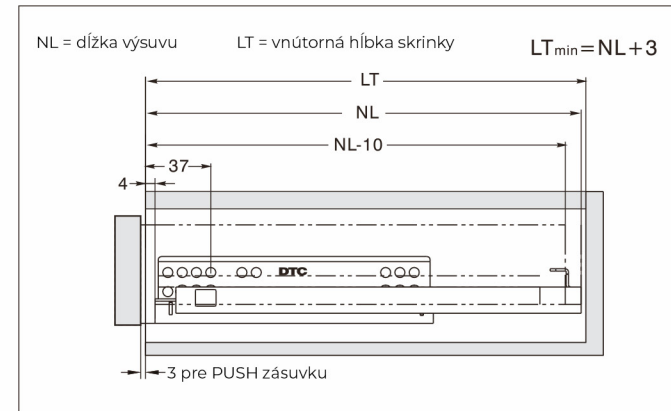

## Vnútorné rozmery zásuvky

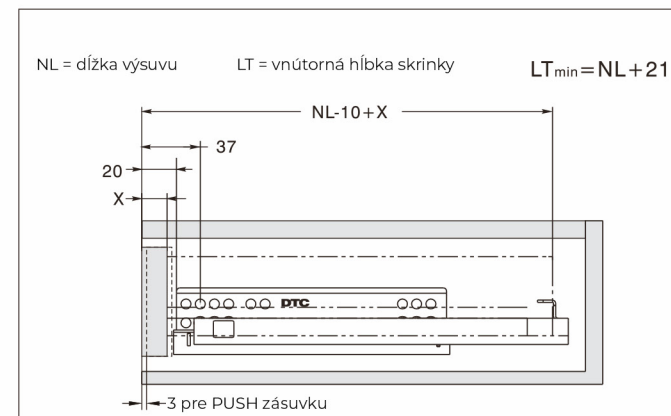

## Príprava zásuvky

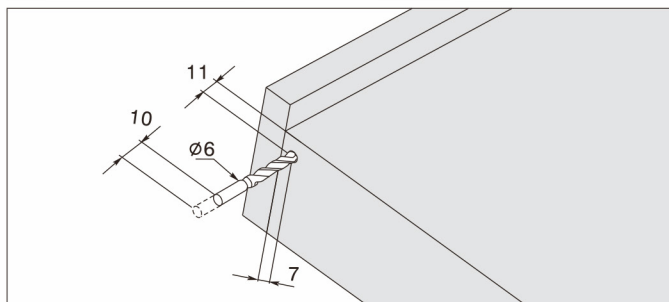

## Príprava zásuvky

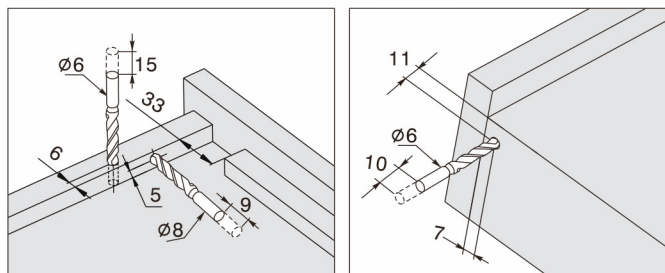

## inštalácia štelovacieho zariadenia

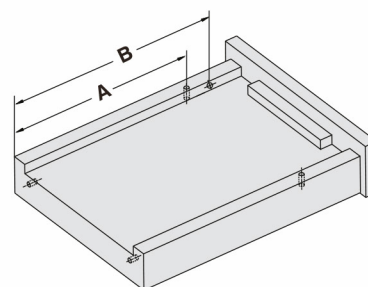
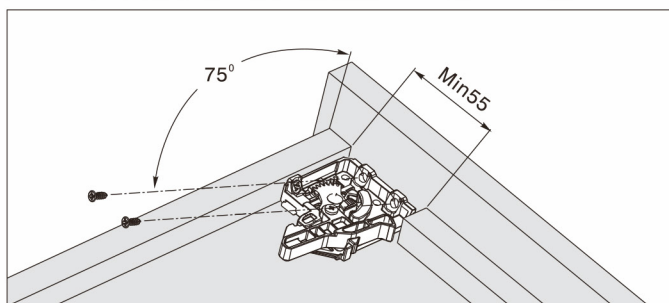

NL (mm)	A (mm)	B (mm)
250	190	200.5
270	205	215.5
300	245	255.5
350	270	280.5
400	305	319.5
450	330	369.5
500	355	419.5
550	390	469.5
600	415	519.5

## Rozmer synchronizačnej tyče

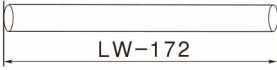
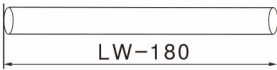
max. 16mm rozmer bočného rezu PUSH zásuvky pre synchronizáciu	 LW-172
max. 19mm rozmer bočného rezu PUSH zásuvky pre synchronizáciu	 LW-180

## Pozícia skrutiek

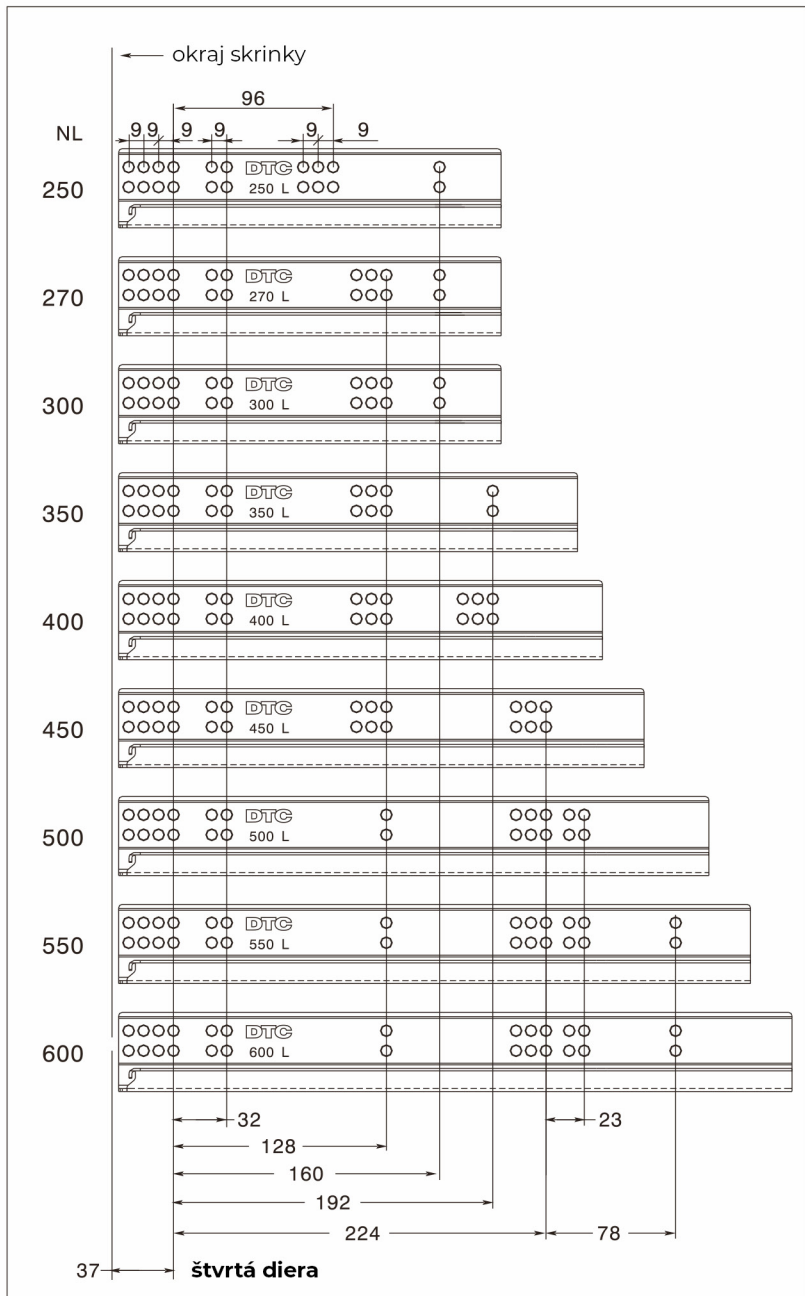

## Montáž a demontáž zásuvky so zaistovacím zariadením

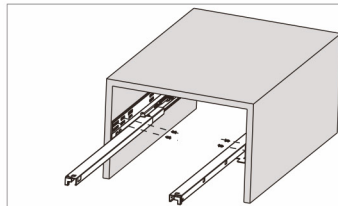

Upevnite výsuvu na skrinku

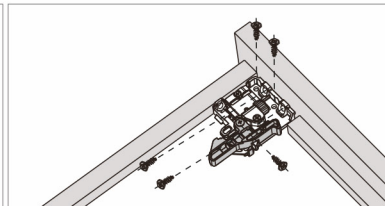

Upevnite štelovacieho zariadenia na spodok zásuvky

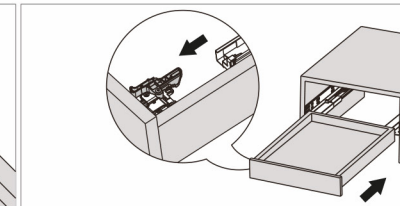

Položte dno zásuvky na výsuv a potom zasuňte zásuvku do skrinky

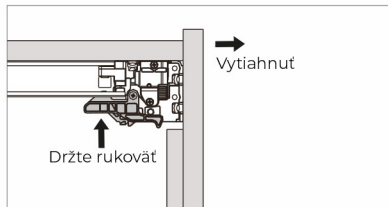

Na vybratie uchopte rukovät a vytiahnite zásuvku

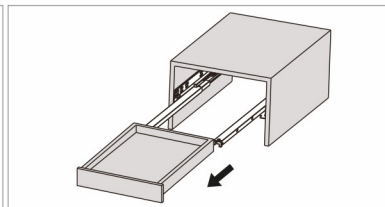

Vytiahnuť

Držte rukovät

## Montáž a vybratie zásuvky pomocou kolíka

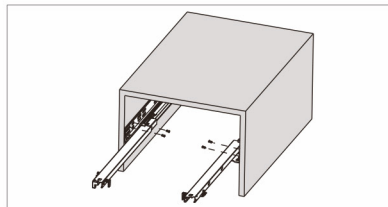

Upevnite výsuvu na skrinku

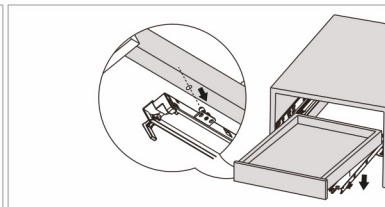

Vytiahnite zásuvkový člen šmykačky zo skrinky, položte zásuvku na šmykačku

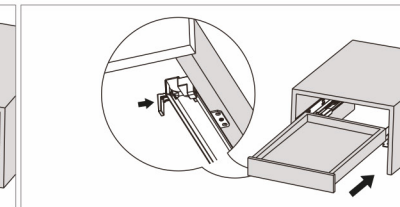

Zatlačením zaistovacieho čapu do strany zásuvky zaistíte polohu zásuvky

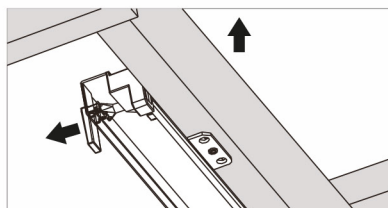

Na vybratie vytiahnite zaistovací kolík zo strany zásuvky. Nadvihnite zásuvku a vytiahnite ju zo skrinky

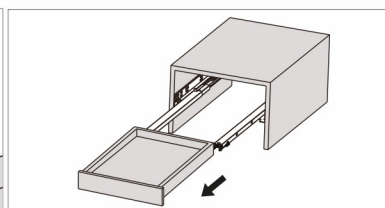

## Synchronizačná zostava Push

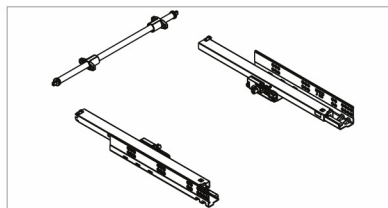

Odrezať tyč

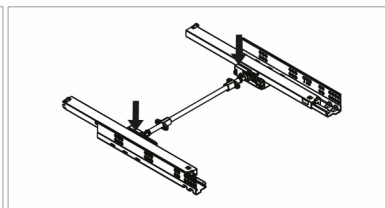

Zacvaknite tyč do zariadenia na otváranie

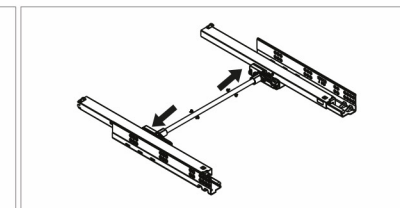

Zaskrutkovať a dokončiť